

Mokona Papercraft

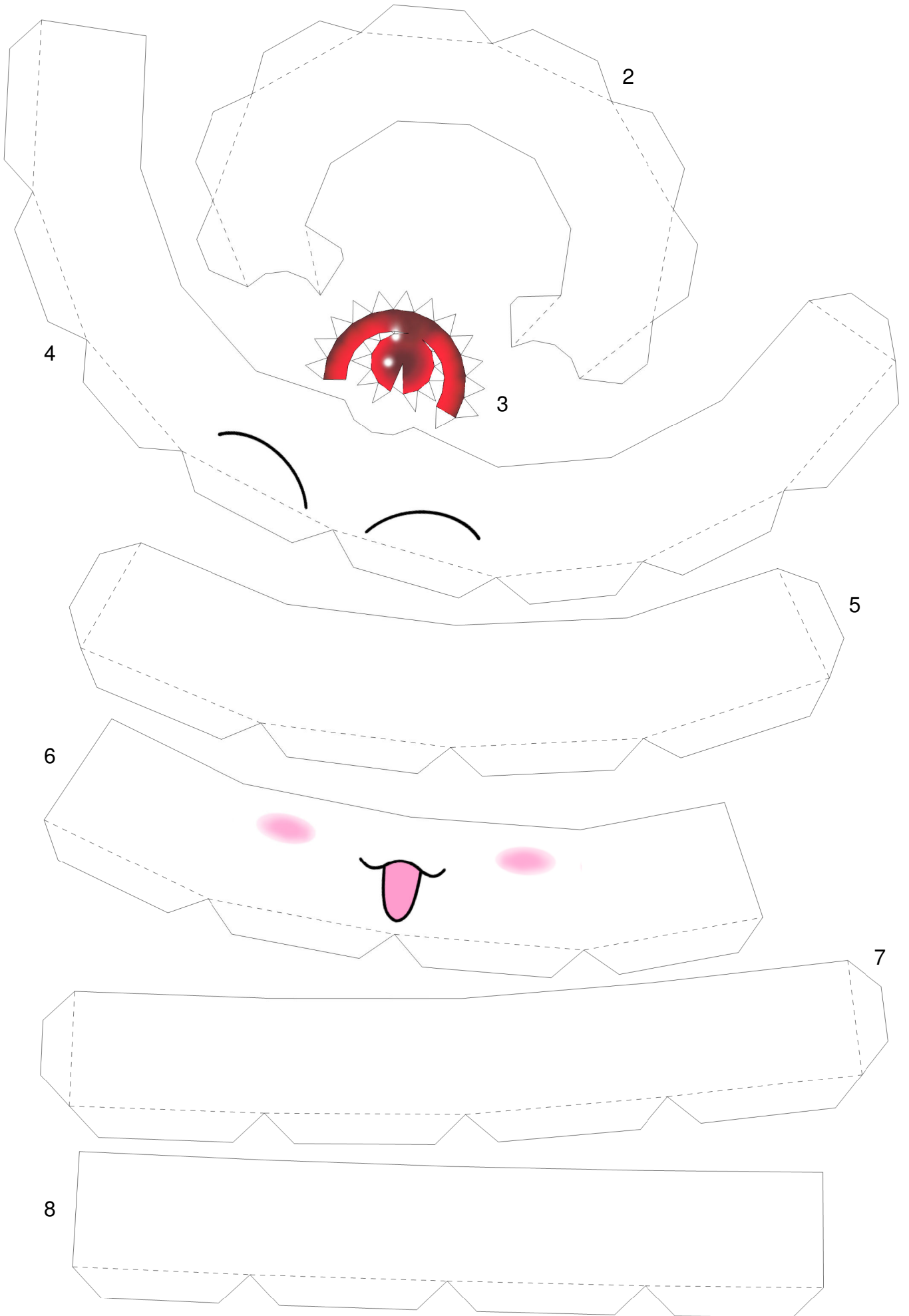

By Lyrin

<http://lyrin-83.deviantart.com/>



9

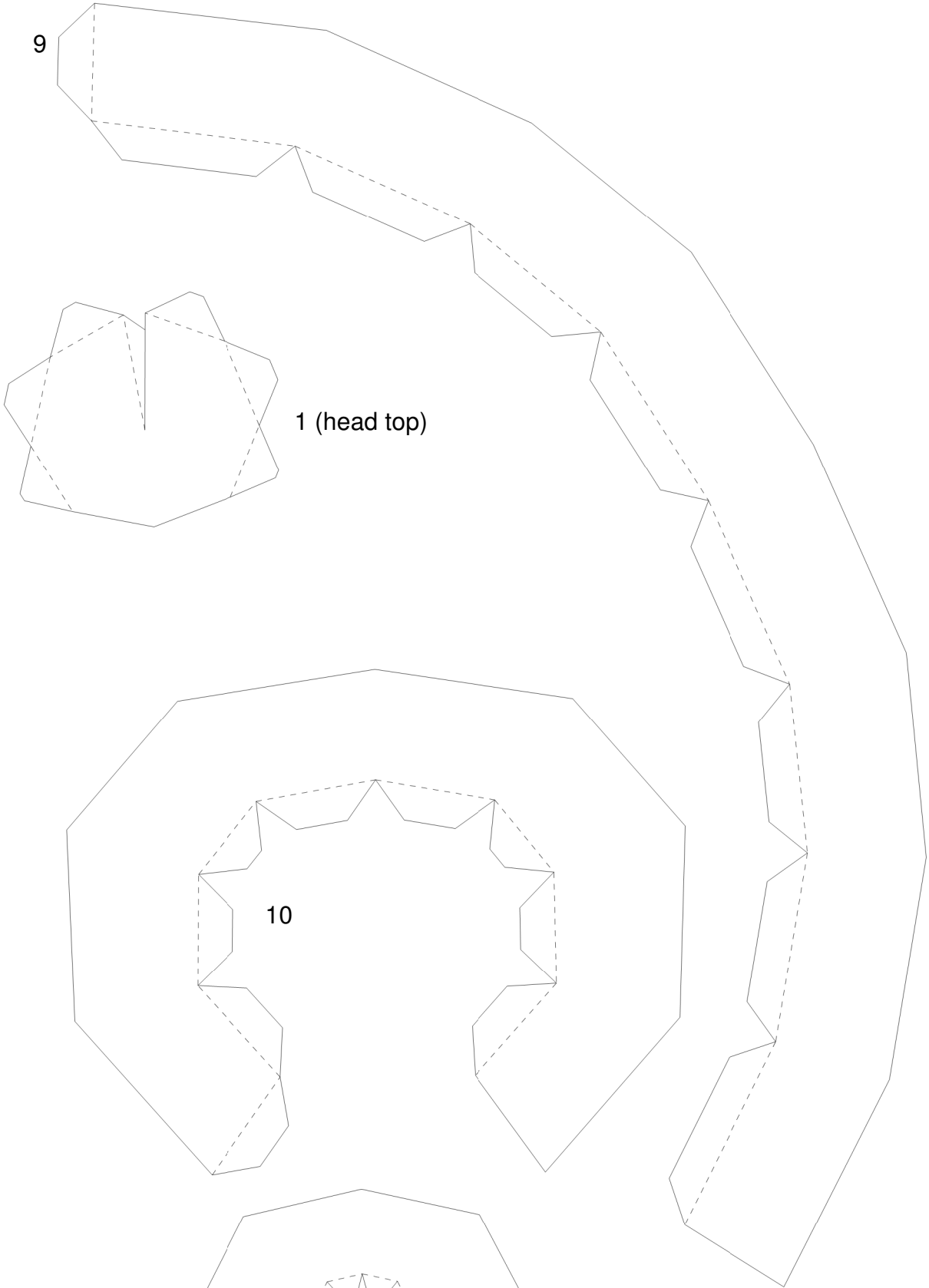

1 (head top)

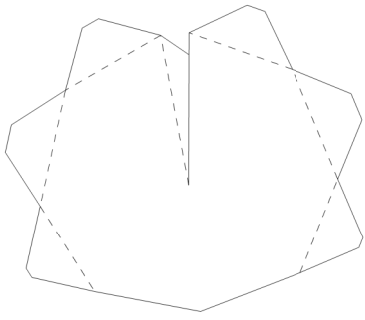

10

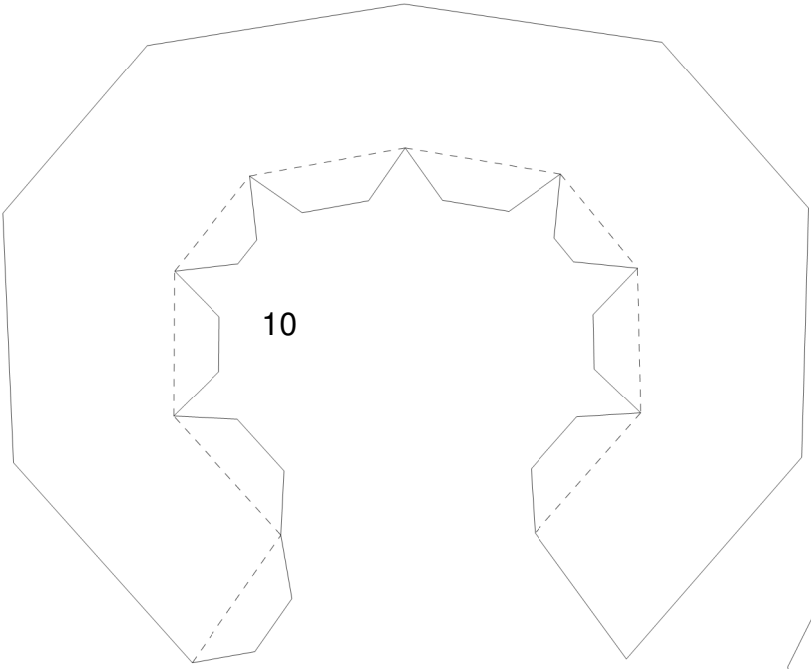

11

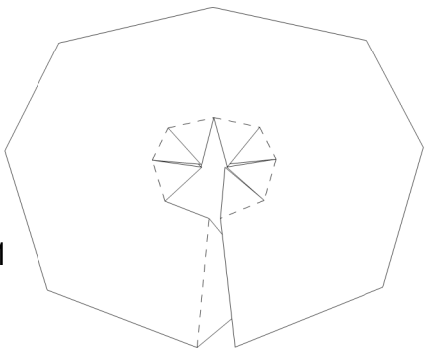

12 (bottom)
close here

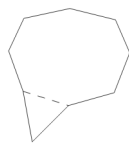

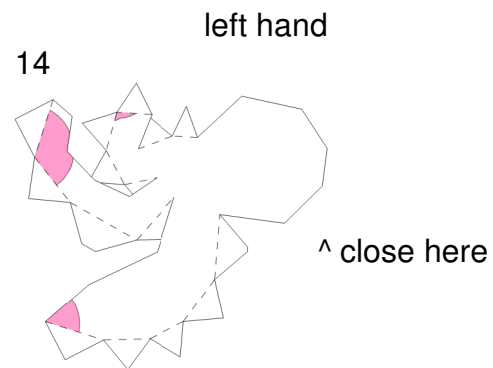
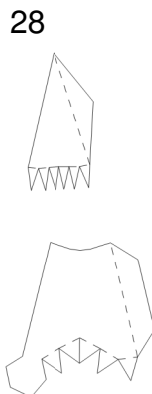
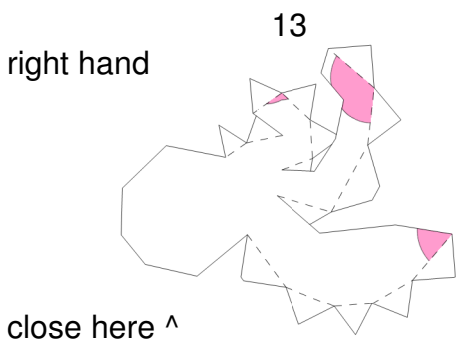

27 tail

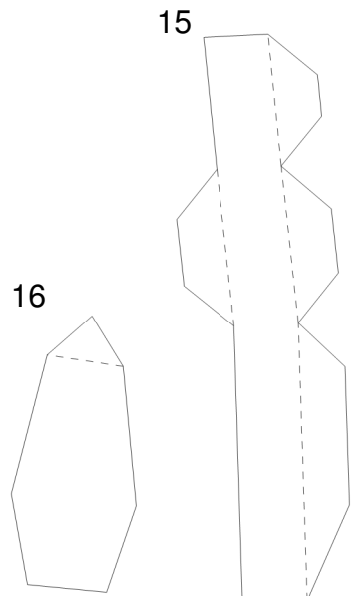

Glue the only tab on piece 16 to its place on piece 15 before starting to glue the rest. Close the foot by gently pressing piece 16 on the tabs of 15. Same goes for pieces 17-18.

